



INDENT CYLINDER SEPARATOR

FUNCTION AND APPLICATION

Pocket cylinder is used for separating all grain substances (wheat, oat, thin seeds lentil, beet seeds, sunflower seed) from unwanted short products and wastes depending on their lengths. These grains may be between 1,0-24 mm. Product passes through the inlet and arrives to internal rotation cylinder and then notches called as active pockets within the container. Grains are carried through after entering into pockets and fall onto internal container out of pockets after being carried to a certain distance. (yellow arrow) They are discharged with other shell wastes. Accordingly, products are separated and graded in accordance with their length and roundness.

SERIAL PRODUCTION

Akyurek Kardesler performs serial production for its machines and ensures short term delivery guarantee. Machines are subjected to quality control test prior to delivery. Therefore, high quality standards and long operation life are guaranteed.

CYLINDER WALL

Cylinder wall is the most important part of the grader. Quality of separation and amount of waste materials depend on manufacturing of the cylinder. Therefore, due diligence is given to workmanship and material utilisation during manufacturing.

CYLINDER SLOPE

Adjustable slope assembly (0-3 degrees) or fixed slope assembly may be attached by us upon request. This operation the result of separation

TYPES OF POCKETS

We provide round and drop shaped pockets based on functions depending on the types of separator. This difference enables us to optimize the grain quality and minimize the waste.

HARDENED PARTS

We may produced hardened parts upon request. Their lives are longer as well as they are used for products with highly corroding products.

REPLACEMENT OF CYLINDER PARTS

The machines is designed with clamps ensuring rapid fixation and removal by dividing the cylinder container into many pieces for replacing the product being processed and keeping cleaning costs at the minimum level possible.

CONTAINER INSULATION

Insulation assembly is available between tub and cylinder in all separator types. This insulation between cylinder and container prevents penetration of unwanted pieces into container and maintains more effective and specialized grain separation.

DRIVERS

Chain, belt or gear pulley drivers are used in our separators for guaranteeing smooth and effective operation. Error and failure risks are reduced and possible operation costs and material failures are minimized. Gear engines used by us are manufactured by one of the leading gear engine manufacturers of the world with wide service network. Therefore, very rapid movement and problem solving can be possible in case of a failure regardless the place on the world.

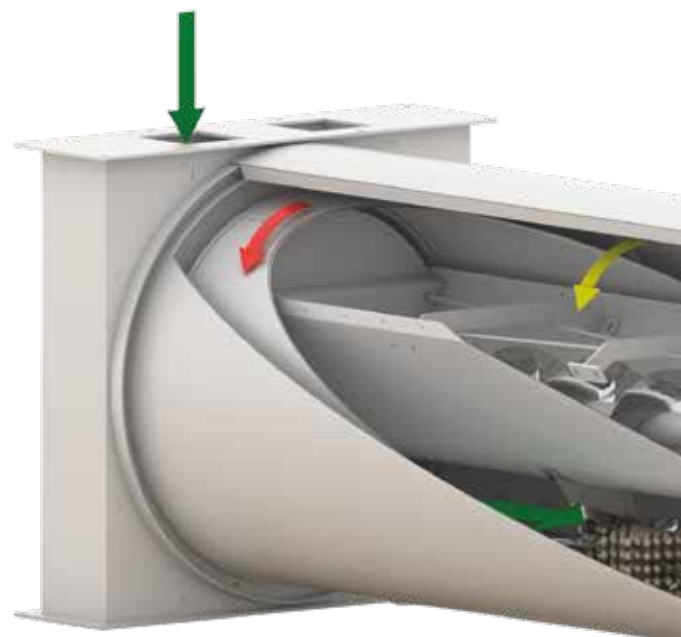

Indent Cylinder Separator

MMCTECH: Seed Machines & Equipment with Automation Solutions

www.mmctech.us

info@mmctech.us

DESIGN

Separators are designed as horizontal cylinder with fully enclosed tub container. This design enables functioning of cylinder parts. When the protection cap is opened, machine is automatically stopped with the safety switch.

CONTROLLING THE SEPARATION

Our separator is designed with two large control windows at exit direction. That enables the user to control correct separation instantly during process without any accident risks. It also enables the user to take samples from control ranges at any time without having any danger risks.

ATEX

Tested in D21 and D22 areas by ATEX during operations performed at environments with potential explosion risk.

POCKET PER CM²

Akyurek Kardesler is one of the rare companies self manufacturing cylinder parts as a grain separator cylinder manufacturer. That makes us independent from external manufacturers and ensures us to fulfil special requirements of pockets those may be created per cm². Therefore, we reach to a higher classification separation speed and a better separation quality than other manufacturer companies.

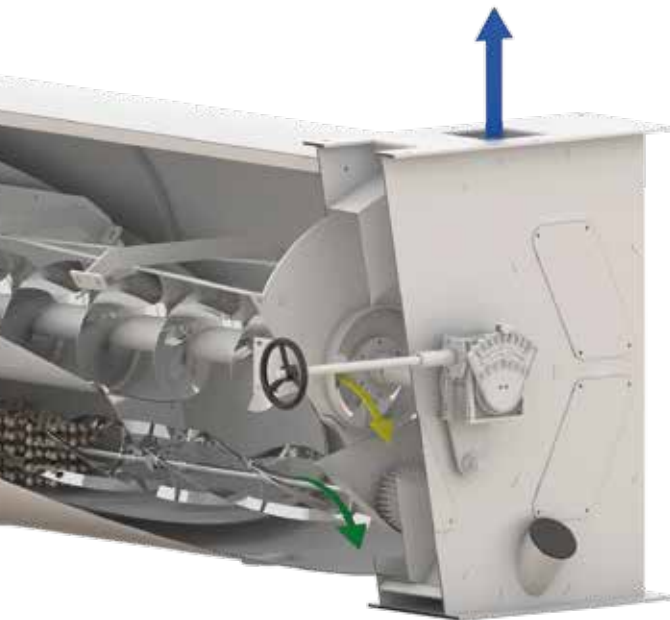

COATING FOR RESISTANCE

An additional coating may be applied for providing resistance in order to protect the machine during processing highly corrosive products.

ADJUSTABLE SPEED

Mechanic or electronic adjustable speed control devices may be supplied upon request.

AUTOMATIC CONTAINER SETTING

Adjustment engine may be added to container arrangement system upon request.

FLOW SCHEMES

A Serially ordered pocket cylinders.

B Parallel ordered pocket cylinders.

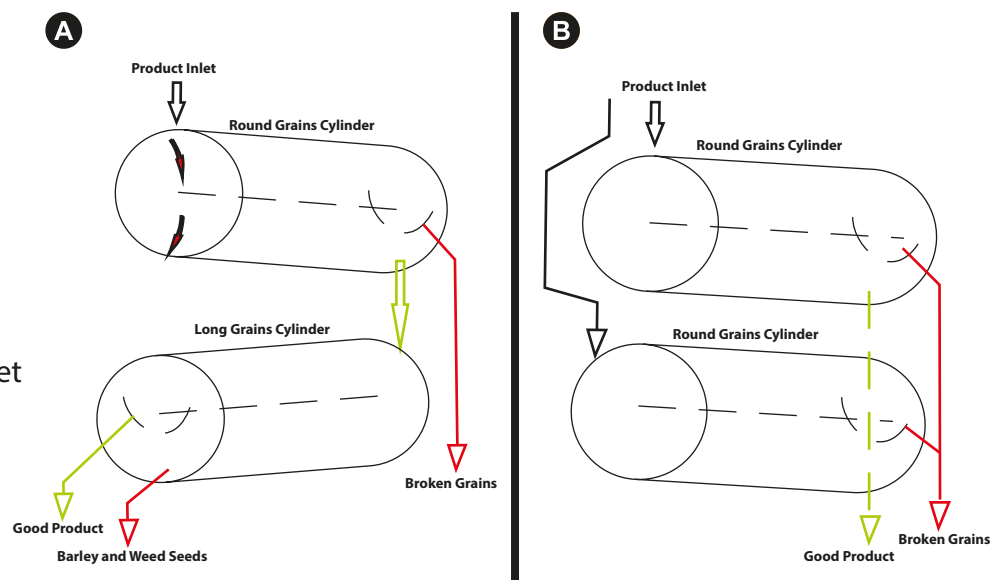

Indent Cylinder Separator

TECHNICAL DATA	Type IC SHORT SEPARATOR									
	ICSS1010	ICSS2010	ICSS3010	ICSS4010	ICSS5010	ICSS6010	ICSS8010	ICSS10010	ICSS12010	ICSS16010
Capacity t/h										
Wheat	1,0	2,0	3,0	4,0	5,0	6,0	8,0	10,0	12,0	16,0
Barley	0,8	1,6	2,4	3,2	4,0	4,8	6,4	8,0	9,6	12,8
Rice (white)	0,4	0,8	1,2	1,6	2,0	2,4	3,2	4,0	4,8	6,4
Motor (standard) kW	0,37	0,55	1,1	1,1	1,1	1,1	3,0	3,0	3,0	4,0
Air requirement m ³ /min	6	7	9	9	9	9	12	12	12	12
Cylinder dim. mm										
∅	400	400	600	600	600	600	900	900	900	900
Length	1000	2000	1500	2000	2500	3000	2000	2500	3000	4000
Dimensions mm										
Length	1760	2840	2545	3045	3545	4045	3320	3820	4325	5325
Width	640	640	860	860	860	860	1202	1202	1202	1202
Height	620	620	870	870	870	870	1240	1240	1240	1240
Net Weight kg	270	370	510	582	620	750	990	1120	1245	1315

Technical data can vary for certain of the above due to continued development or a different machine composition.

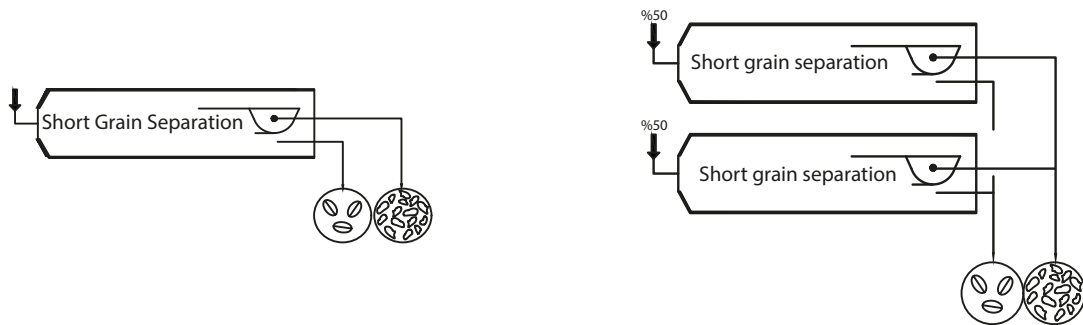

TECHNICAL DATA	Type IC LONG SEPARATOR									
	ICLS1010	ICLS2010	ICLS3010	ICLS4010	ICLS5010	ICLS6010	ICLS8010	ICLS10010	ICLS12010	ICLS16010
Capacity t/h										
Wheat	1,0	2,0	3,0	4,0	5,0	6,0	8,0	10,0	12,0	16,0
Barley	0,8	1,6	2,4	3,2	4,0	4,8	6,4	8,0	9,6	12,8
Rice (white)	0,4	0,8	1,2	1,6	2,0	2,4	3,2	4,0	4,8	6,4
Motor (standard) kW	0,37	0,55	1,1	1,1	1,1	1,1	3,0	3,0	3,0	4,0
Air requirement m ³ /min	6	7	9	9	9	9	12	12	12	12
Cylinder dim. mm										
∅	400	400	600	600	600	600	900	900	900	900
Length	1000	2000	1500	2000	2500	3000	2000	2500	3000	4000
Dimensions mm										
Length	1760	2840	2545	3045	3545	4045	3320	3820	4325	5325
Width	640	640	860	860	860	860	1202	1202	1202	1202
Height	620	620	870	870	870	870	1240	1240	1240	1240
Net Weight kg	270	370	510	582	620	750	990	1120	1245	1315

Technical data can vary for certain of the above due to continued development or a different machine composition.

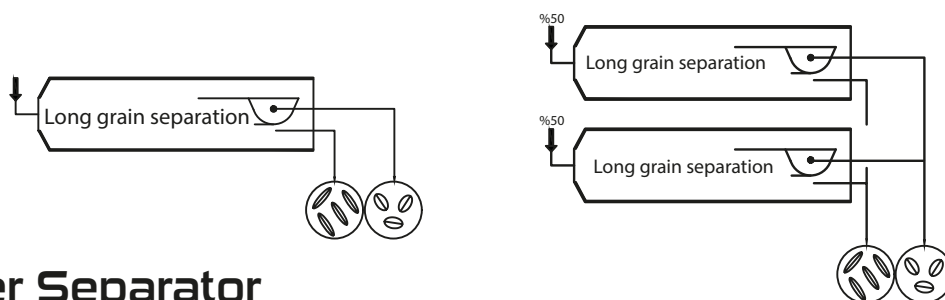

Indent Cylinder Separator

MMCTECH: Seed Machines & Equipment with Automation Solutions

www.mmctech.us

info@mmctech.us

TECHNICAL DATA	Type IC SHORT & LONG SEPARATOR									
	ICSL1020	ICSL2020	ICSL3020	ICSL4020	ICSL5020	ICSL6020	ICSL8020	ICSL10020	ICSL12020	ICSL16020
Capacity t/h										
Wheat	1,0	2,0	3,0	4,0	5,0	6,0	8,0	10,0	12,0	16,0
Barley	0,8	1,6	2,4	3,2	4,0	4,8	6,4	8,0	9,6	12,8
Rice (white)	0,4	0,8	1,2	1,6	2,0	2,4	3,2	4,0	4,8	6,4
Motor (standard) kW	2x0,37	2x0,55	2x1,1	2x1,1	2x1,1	2x1,1	2x3,0	2x3,0	2x3,0	2x4,0
Air requirement m ³ /min	6	7	9	9	9	9	12	12	12	12
Cylinder dim. mm										
∅	400	400	600	600	600	600	900	900	900	900
Length	1000	2000	1500	2000	2500	3000	2000	2500	3000	4000
Dimensions mm										
Length	2107	3145	2905	3405	3905	4445	3765	4265	4765	5775
Width	640	640	860	860	860	860	1202	1202	1202	1205
Height	1240	1240	1740	1740	1740	1740	2480	2480	2480	2480
Net Weight kg	540	740	1020	1170	1240	1500	1980	2240	2490	2630

Technical data can vary for certain of the above due to continued development or a different machine composition.

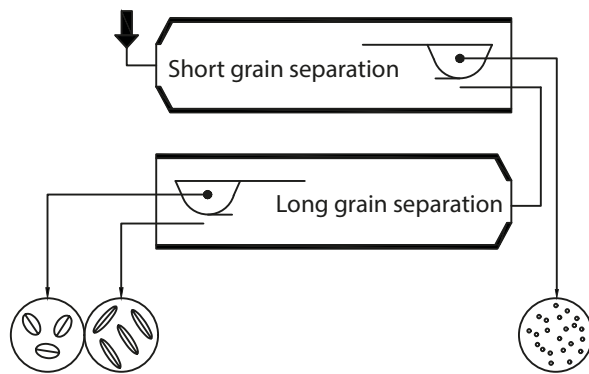

TECHNICAL DATA	Type IC SPLITTER & SHORT & LONG SEPARATOR									
	1030	2030	3030	4030	5030	6030	8030	10030	12030	16030
Motor (standard) kW	3x0,25	3x0,55	3x1,1	3x1,1	3x1,1	3x1,1	3x3,0	3x3,0	3x3,0	3x4,0
Air Requirement m ³ /min	12	14	18	18	18	18	24	24	24	24
Cylinder dim. mm										
∅	400	400	600	600	600	600	900	900	900	900
Length	1000	2000	1500	2000	2500	3000	2000	2500	3000	4000
Dimensions mm										
Length	2107	3145	2905	3405	3905	4405	3765	4765	4765	5775
Width	640	640	860	860	860	860	1202	1202	1202	1205
Height	1860	1860	2610	2610	2610	2610	3720	3720	3720	3715
Net Weight kg	810	1110	1530	1760	1860	2250	2970	3360	3735	3540

Technical data can vary for certain of the above due to continued development or a different machine composition.

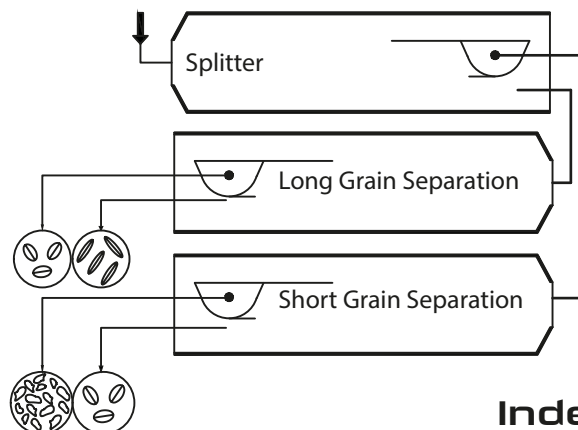

Indent Cylinder Separator